

Manufacturing Process Interoperability Scenario



National Institute of Standards and Technology (NIST)¹



Systems Integration for Manufacturing Applications (SIMA) Program²

Manufacturing Systems Integration Division (MSID)³
Unified Process Specification Language (PSL)



Stephen T. Polyak and Stuart Aitken
AIAI-PR-68

Artificial Intelligence Applications Institute (AIAI)⁴
The University of Edinburgh
80 South Bridge, Edinburgh EH1 1HN
United Kingdom
E-mail: {Steve_Polyak,S.Aitken}@ed.ac.uk

April 22, 1998

¹NIST is an agency of the U.S. Department of Commerce's Technology Administration.

²The SIMA Program is an inter-laboratory effort at NIST applying information technology solutions to manufacturing systems integration problems under the U.S. government's High Performance Computing and Communications initiative.

³MSID is one of five divisions of the Manufacturing Engineering Lab at NIST which promotes the development of technologies and standards that lead to the implementation of information-intensive manufacturing systems that can be integrated into a national network of enterprises working together to make U.S. industry more productive.

⁴AIAI is a technology transfer organisation at the University of Edinburgh that promotes and expedites the application of research on Artificial Intelligence for the benefit of industrial, commercial, government and academic clients.

Contents

1	Executive Summary	2
2	Introduction	2
2.1	Source and Target Representations	3
2.2	Overview	3
3	The Camile Motor Works Factory	3
4	The Product: GT-350	4
5	The Departments	5
5.1	Foundry	5
5.2	Rubber Works	7
5.3	Sheet Metal	10
5.4	Machine Shop	12
5.5	Wire and Cable	13
5.6	Electronics	15
5.7	Paint	18
5.8	Final Assembly	19
6	GT-350 Manufacturing Processes	21
6.1	Make Interior	22
6.2	Make Drive	22
6.3	Make Trim	22
6.3.1	Make Options	23
6.3.2	Make Wheels	24
6.3.3	Make ID Plate	24
6.4	Make Engine	24
6.4.1	Make Block	25
6.4.2	Make Harness	25
6.4.3	Make Wires	26
6.5	Make Chassis	26
6.5.1	Make Unibody	27
6.5.2	Make Frame	27
6.6	Final Assembly	28
7	GT-350 Manufacturing Material Flow	29
8	Source and Target Languages	30
8.1	IDEF3: Process Representation	30
8.2	ILOG Schedule: Scheduling	31
9	Summary	32

1 Executive Summary

The National Institute of Standards and Technology's (NIST) Process Specification Language (PSL) project is motivated by a need for an integrated manufacturing environment in which process information can be shared amongst various applications. In phase two of the PSL project, a number of analyses of existing process-related representations [Knutilla *et al.* 97, Polyak & Tate 97] were produced based on the requirements gathered in the initial phase [Gruninger *et al.* 97, Schlenoff *et al.* 96]. Following on from this work in phase three, a set of primitive PSL concepts were identified for this language [Schlenoff *et al.* 97]. These concepts address core aspects of manufacturing process knowledge. These core aspects have been incorporated into the default language presentation of the PSL. This document describes a scenario in which this language can be used to exchange a standard representation of process knowledge between two manufacturing functions: process planning and job shop scheduling.

2 Introduction

This purpose of this document is to provide a detailed scenario in which the National Institute of Standards and Technology's (NIST) Process Specification Language (PSL) could be used in a knowledge-sharing effort which involves multiple manufacturing functions. This description seeks to assist in the development of the PSL in a number of ways. Some uses of this scenario may be to

- Assist in making PSL goals concrete
- Motivate mechanisms of extension, representation, translation, etc.
- Ensure that PSL is capable of addressing realistic applications
- Serve as a practical example to potential end-users
- Aid in the understanding of the language
- Assist in the development of the language's semantics and presentation

This particular scenario is an "interoperability" manufacturing scenario. This means that its goal is to show how PSL can be used to facilitate the communication of process knowledge in a manufacturing environment. Specifically, this scenario is centred around the exchange of knowledge from a process planner to a job shop scheduler. The following text illustrates the manufacturing context in which this exchange occurs¹

"A manufacturing firm makes a number of products. Associated with each product is a unique part number and one or more process plans. One process plan may be the preferred alternative, but the other alternatives are equally valid and yield acceptable parts. The process plan has a list of operations that must be performed in that sequence. The process plan has certain information about each operation: the operation name, the required resources, the planned run time, the planned setup time, the various parameters, etc.

At a given point in time, the firm has a set of customer orders. Each order has a due date and requests a certain number of some parts. Completing the order means completing every operation in some process plan for that product.

The production scheduling person must schedule the shop. That is, this person must create a schedule that states, for each customer order and each necessary operation, the workcenter that should perform the operation, when the operation should begin, and when it should complete. The schedule is given to the manufacturing employees, who attempt to follow the schedule."

¹This text was adapted from a scenario description submitted to the PSL scenario group by Jeffrey Herrmann, University of Maryland, College Park.

This scenario is concerned in particular with the exchange of the process plan knowledge described above. It is assumed that each manufacturing function has its own “native” representation which is suited to the particular tools which are specialised for that function (i.e. a process planner uses a process planning tool and a scheduler uses a scheduling tool). Obviously, interoperability is a trivial act if the co-participants natively share a common language/representation. The “interesting” aspect of this communication is the translation involved.

The following interoperability steps are proposed to facilitate this communication: (1) a process plan representation is translated into PSL and (2) this PSL representation is translated into a scheduling representation. Alternatively, a translator could be written directly between the two (source and target) representations. This has the disadvantage of increasing the number of translators needed from $O(n)$ to $O(n^2)$ (where n = number of translators) when translation with more representations are required (e.g. between the scheduler and floor control system).

2.1 Source and Target Representations

The representations used for this example are IDEF3 [Mayer *et al.* 92] and ILOG Scheduler [Pape 94] for the process planning and scheduling functions, respectively. IDEF3 was created specifically to capture descriptions of sequences of activities and has become a well-known representation for process knowledge. This is discussed in more detail in section 8.1. ILOG Scheduler is an add-on to the popular ILOG Solver library which is designed for finite capacity scheduling applications. This is discussed in more detail in section 8.2.

2.2 Overview

This document is divided into six parts. The first part, section 3, presents a brief description of the fictitious factory which manufactures the scenario product. Section 4 outlines the product and the product sub-structure. The factory departments are examined in detail, along with the processes they enact in section 5. Two high-level perspectives which unite the departmental descriptions are provided in sections 6 and 7. Finally, section 8 provides simple examples of the process knowledge expressed in the source IDEF3 and target ILOG Scheduler representations.

3 The Camile Motor Works Factory

The product, process, and factory knowledge presented in this scenario has been taken from a planning and control reference case study developed by members of the Waterloo Management of Integrated Manufacturing Systems (WAT-MIMS) Research Group in 1991 entitled “Intelligent Manufacturing Management Program State of the Art Scheduling Survey” [McKay & Moore 91]. In this work, the authors provide a detailed account of a fictitious factory, the Camile Motor Works (CMW). Each characteristic and concept documented for this factory is based on factors which have been observed to be critical for decision making (predictive or reactive) in one or more “real” factories.

This case study covers normal manufacturing planning and control activities from the time of work order acceptance, including due date negotiation, to the time when final products are stored or shipped. CMW is described as a factory which produces a line of scale model automobiles which are constructed using

- a number of purchased parts used during assembly
- purchased parts which have additional internal processing (assembling, painting, etc.)
- internally fabricated components transformed from raw materials (various bodies, name plates, gear shifts, frames, engine block, spark plug wires, tires, rims, etc.)

CMW has a wide variety of manufacturing processes at the factory and can be considered a hybrid environment. There are eight major departments (see section 5) comprised of 43 primary resources. The factory employs approximately 50 direct labour personnel which operate the plant and maintain the resources.

4 The Product: GT-350

While three products are presented in the source factory description (GT-200, GT-250, GT-350), it is sufficient for this interoperability scenario to restrict the scope to only address the most complex of the three. The GT-350 is described as a sophisticated running scale model automobile that is marketed via direct mail to company executives with optional license plates (various types to choose from). The product can be further personalised with the buyer's choice of 2 to 6 characters placed on an ID plate. The model comes in red or white (batteries not included). This high priced item is not stocked and is built only when firm orders are given. Delivery times of 4 to 6 weeks are indicated to buyers.

The product structure for the GT-350 is shown in table 1. The indenting of names is used to indicate the part sub-component structure. An unique part number is assigned to each component. The method of manufacturing for each component is listed in the right-most column. Some parts are manufactured internally or are assembled from other parts, while others are purchased or sub-contracted externally.

GT-350 Product Structure			
Part Name	Quantity	Part Number	Method
chassis	1	350-CHASSIS	assembled
doors	2	x50-DOORS	purchased
unibody	1	x50-BODY	internal
frame	1	350-FRAME	internal
engine	1	350-ENGINE	assembled
block	1	350-BLOCK	internal
harness	1	350-HARNESS	internal
wires	1	350-WIRE-SET	internal
partial wire	12	350-WIRE	internal
partial wire	1	x50-WIRE	internal
drive	1	350-DRIVE	assembled
motor	1	350-MOTOR	purchased
electronics	1	350-PCB	internal
interior	1	350-INTERIOR	assembled
cockpit	1	350-COCKPIT	sub-contract
dash	1	350-DASH	purchased
lights	2	350-LIGHTS	purchased
seats	1	350-SEATS	purchased
gear shift	1	x50-GEAR	internal
trim	1	350-TRIM	assembled
options	1	350-OPTIONS	assembled
license plates	2	350-LICENSE	internal
wheels	4	350-WHEELS	assembled
tires	1	350-TIRES	internal
rims	1	350-RIMS	internal
decals	1	350-DECALS	purchased
id-plate	1	350-PLATE	internal
stand	1	350-STAND	internal

Table 1: GT-350 Product Structure Table

5 The Departments

This section provides a synopsis of the CMW departments. The focus is on the presentation of a set of IDEF3 models which describe the departmental processes that are involved in the production of GT-350 products. These models combine both a process centred view using process flow diagrams and an object-centred view using the object state transition network diagrams. Additionally, there is an emphasis on factory knowledge which is relevant to scheduling the processes (e.g. shift times, maintenance schedules, etc.). This process and scheduling-related factory knowledge combined with order, product and knowledge of the existing schedule comprise an overall input to the job shop scheduling function. The descriptions of the factory provide examples of prevelant concepts such as process, precedence, and object states, etc. but also more subtle/complex concepts which are shown by example, e.g. maintenance schedules, resource constraints. The grouping and mapping of the concepts described in this document to the NIST PSL will be an exercise which will involve participation from the semantics, presentation and scenario teams.

5.1 Foundry

The foundry produces shaped metal parts from metal compounds by melting the compound and moulding the part. The parts manufactured in this way are the 350-block and x50-rim.

There are 3 furnaces (F001-3) and one mould (F004) in the foundry. The sequence of production steps is shown in Figure 1. Note that this diagram does not show maintenance operations.

Use of the resources is restricted as follows: The three furnaces F001-3 have the following minimum load weights: 250, 500, 750 pounds, maximum load weights are: 500, 750, 1000, warm up times are: 1, 2, 3 hours, and cool off periods are: 2, 4, 6 hours respectively. Only two furnaces may be on at any one time due to their power consumption.

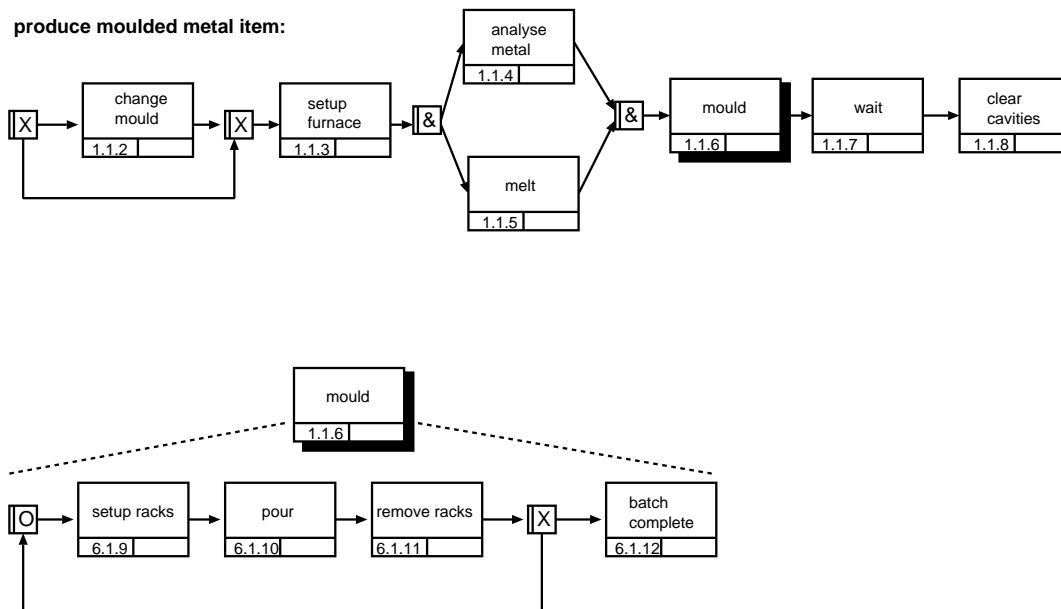

Figure 1: Production steps in the foundry

The process steps require the following materials and resources:

change mould Requires: the mould F004, 2 operators, takes 2 hours, change mould is performed when the part number changes, and a maximum of 20 mould changes are permitted per week.

setup furnace Requires: a furnace F001-3, 1 operator is required for the first 30 minutes of warm up, warm up time depends on the furnace selected.

melt Requires: a furnace F001-3, 10% of the time of 1 operator. Each 350-block requires 1/6 pound of metal, and melt takes 2 hours. Each x50-rim requires 0.5 pound of metal, and melt takes 2 hours. Note that furnace capacity depends on the furnace selected.

analyse metal Requires: analysis of the metal in the furnace establishes the composition.

setup racks Requires: the mould F004, 2 operators, 2 racks are processed at the same time (3 in the case of 350-block), each rack takes 2 minutes to setup (12 minutes in the case of 350-block). A rack holds 100 350-blocks and 100 x50-rims. A rack holds 50 200-bodys, 100 350-blocks, 50 250-frames, and 100 x50-rims. Each is held in a cavity.

pour Requires: the mould F004, 2 operators, pouring takes 10 minutes per rack.

remove racks Requires: the mould F004, 2 operators, removal takes 2 minutes per rack, storage space is unlimited.

batch complete If the batch is complete *mould* ends, otherwise more racks must be setup, poured and removed as described above.

wait Requires: each rack requires 24 hours to cool down.

clear cavities Requires: 0.5 minutes per cavity if 3 operators are involved, 0.75 minutes if 2 operators are involved, 1.25 minutes if 1 operator is involved.

In scheduling, the following facts must also be accounted for:

- The foundry operates two eight hour shifts per day 8:00–24:00, Monday-Friday.
- Batches at the furnace and mould cannot span the 24:00–8:00 gap, i.e. they must be completed by 24:00.
- The foundry may authorise 1 or 2 hours of overtime to allow a batch to be completed.
- Each furnace requires 4 hours of preventative maintenance for every 100 hours of processing time. Not more than 105 hours can elapse without preventative maintenance. Preventative maintenance can be scheduled early.
- Preventative maintenance is scheduled for the moulder on the first day of each month. This takes 2 hours.
- There are no storage constraints.

The object state transitions for the production of x50-rims and 350-blocks are shown in Figure 2. These diagrams show the changes to the physical objects being manufactured: the input material is a solid metal compound, this is transformed into molten metal, which is then poured into a set of cavities. Cooling produces a set of solid cavity mouldings, which are then cleared to produce a batch of x50-rims/350-blocks. In these diagrams, *referents* (i.e. nodes which provide additional information) are shown as rectangles. Where the referent makes a reference to a unit of behaviour (UOB) in the process model, this is indicated by preceding the process name with *UOB/*. The production processes for these components are identical. The selection of the type of mould determines the component type.

produce x50-rims:

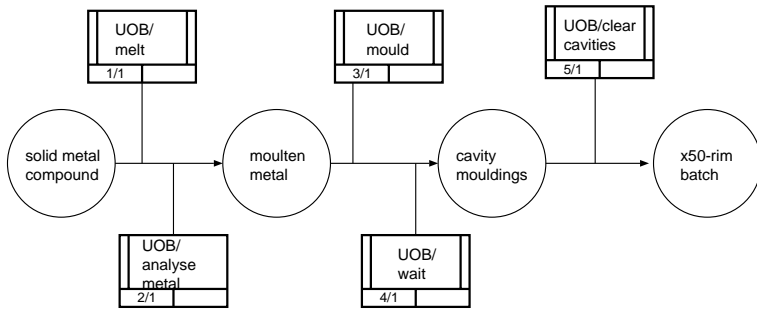

produce 350-block:

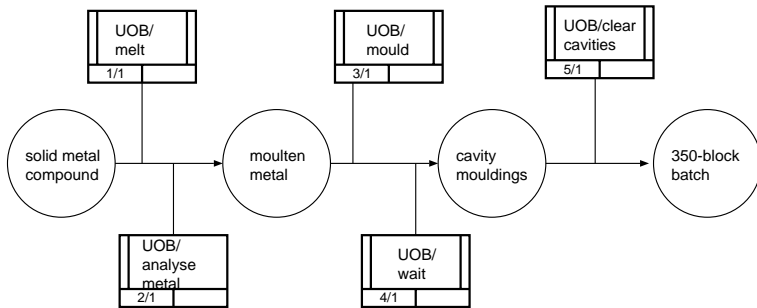

Figure 2: Object state transitions in the foundry

5.2 Rubber Works

The rubber works produces tires (350-tires) and gear shifts (x50-gear shifts). Tires are made by mixing raw rubber compound, extruding a plug, then sawing the individual tires from the plug. Gear shifts are made by mixing raw rubber compound and moulding the part. The moulds must be heated prior to moulding.

There are five machine resources in the rubber works: mixer R001, extruder R002, saw R003, heater R004, and moulder R005.

Use of the resources is restricted as follows: The rubber output by the mixer must be stored prior to extrusion or moulding, storage is limited to 1000 pounds upline of the extruder, 1500 pounds upline of the moulder. Only 5 % of the rubber batch can be extruded or moulded prior to positive analysis results.

Two processes are enacted in the rubber works: *produce tire* and *produce gear shift*. Figure 3 shows the processes of *produce tire*, and their dependencies. These process steps require the following materials and resources:

analyse rubber Requires: analysis of the rubber in the mixer is done off-line and may cause the batch to fail. Salvage of the mix is described below.

mix Requires: mixer R001, mixing takes 3 hours, 1/6 pound of raw rubber compound is required per 350-tire,

produce tire:

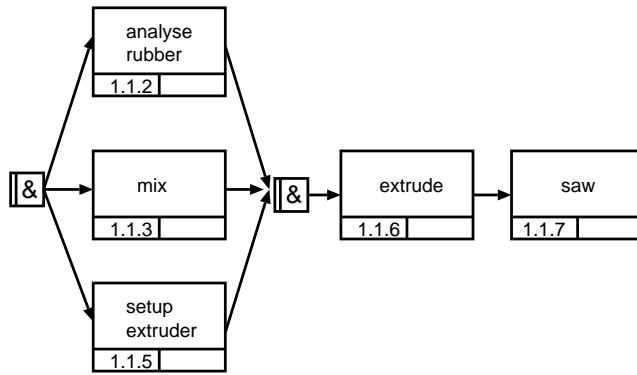

Figure 3: Production steps in the rubber works

setup extruder Requires: extruder R002, setup takes 2 hours.

extrude Requires: extruder R002, takes 30 minutes for the first plug to appear, plugs which will make 350-tires then arrive at 10 second intervals, the input queue is constrained, see above.

saw Requires: saw R003, the rubber plugs will make 2 raw 350-tires, the saw fixture must be full, the saw takes 2 minutes per raw tire, two final 350-tires are produced from each raw tire. Sawing can begin as soon as the rubber leaves the extruder, and sawing is a slower process than extrusion so work in progress can accumulate.

Should the rubber mix fail the analysis, extrusion or moulding must stop and the batch salvaged. Salvage takes 1 hour and involves flushing and cleaning the tanks and machines.

In scheduling, the following facts must also be accounted for:

- The setup processes can be on the first shift and the extrude/saw processes on the second (but need not be).
- The saw blade must be changed after every 600 raw tires. Changing the blade takes 1 hour.
- Replacement blades may not be available, and it takes 24 hours to recondition a blade.

Figure 4 shows the process steps for the *produce gear shift* process. These process steps require the following materials and resources:

clean moulder Requires: moulder R005, takes 2 hours, mixing is not performed unless the moulding machine is clean. The moulder is cleaned before every batch.

analyse rubber Requires: analysis of the rubber in the mixer is done off-line and may cause the batch to fail. Salvage of the mix is as described above.

mix Requires: mixer R001, mixing takes 3 hours, each x50 gear shift requires 1/12 pound of raw rubber compound.

pre-heat mould Requires: heater R004, pre-heating takes 3 hours.

fill moulder Requires: moulder R005, 10 gear shifts are moulded at a time, filling takes 2 minutes. Note the input queue restriction for the moulder stated above.

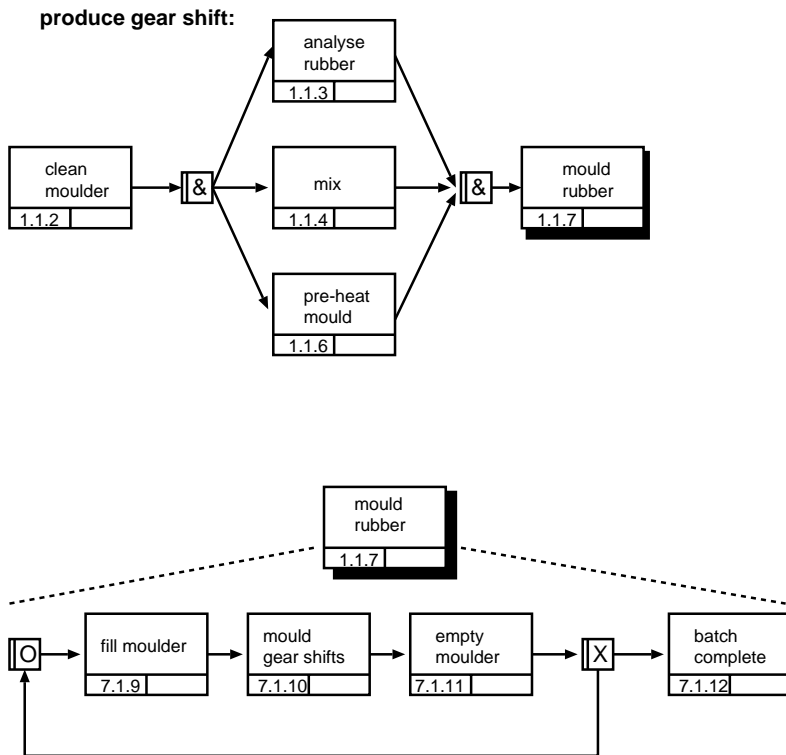

Figure 4: Production steps in the rubber works

mould gear shifts moulder R005, the mould operation takes 2 minutes.

empty moulder moulder R005, takes 2 minutes.

batch complete If the batch is complete *mould rubber* ends, otherwise the moulder is filled, operated and emptied as above.

Should the rubber mix fail the analysis, salvage occur as described above.

In scheduling, the following facts must also be accounted for:

- The setup processes and the mould processes must be on the same shift.
- The pre-heating operation can only be performed on Tuesday or Thursday on the day shift.

The object state transitions for the production of 350-tires and x50-gear shifts are shown in Figure 5. In both cases, liquid rubber is produced from solid rubber compound. The 350-tire production process uses an extruder to produce solid rubber plugs, which are then sawn to the correct shape. The x50-gear shifts production process moulds the liquid rubber directly into the final shape. Figure 5 shows the transition which occurs when the analysis of the rubber fails: the rubber remains in the molten state while the batch is salvaged.

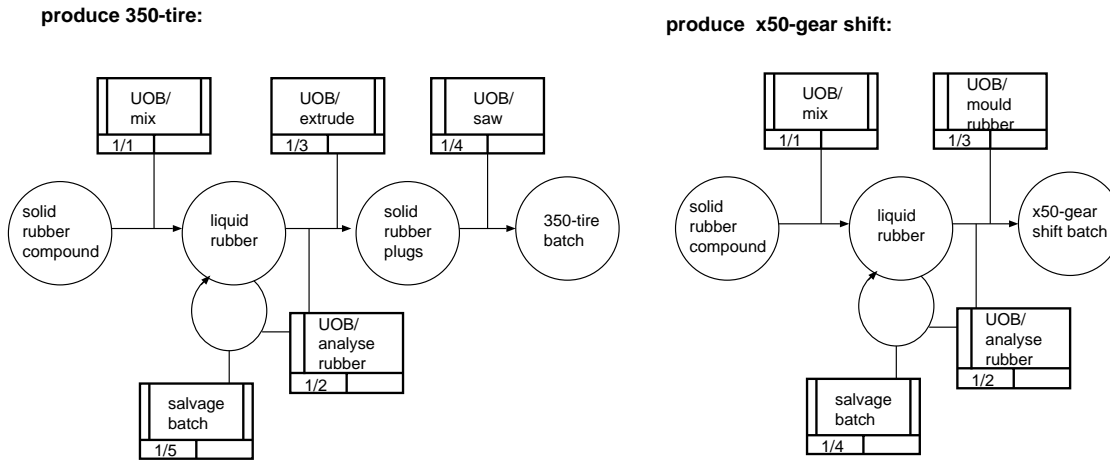

Figure 5: Object state transitions in the rubber works

5.3 Sheet Metal

The sheet metal department produces a number of parts for the GT-350 from a material supply of sheet metal. The parts manufactured include: 350-License, x50-Body, 350-ID Plate and an unpainted 350-Frame.

There are 3 machines in the sheet metal area: a plasma cutting station (S001), a sheet metal punch (S002), and a sheet metal press (S003). The alternate sequences of production steps are shown in figure 6. These sequences represent unique activity paths enacted within the department. The particular sequence performed depends on the part which is being produced. The object state transition diagram for the sheet metal department in figure 7 ties an activity flow to the particular manufactured part.

The process steps require the following materials and resources:

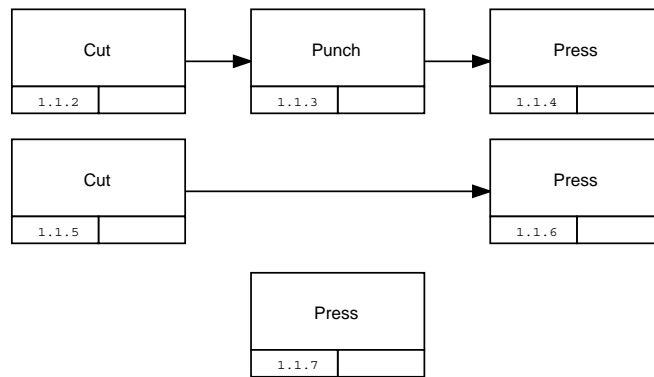

Figure 6: Production Steps in the sheet metal department

cut (1.1.2) - 350-Frame Requires: plasma cutter S001, 4 minutes for setup, load time per sheet is 1 minute, 1 sheet gives 1 part, 60 seconds per part.

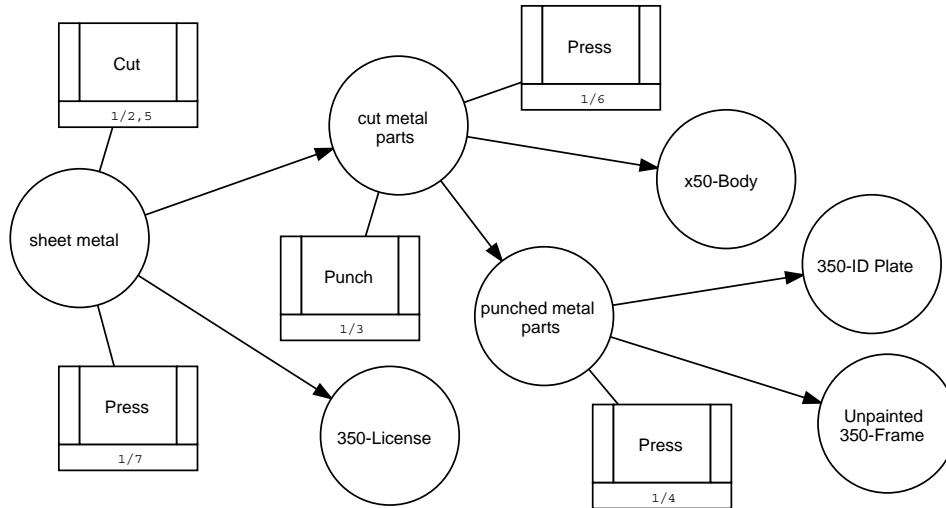

Figure 7: Object state transitions in the sheet metal department

punch (1.1.3) - 350-Frame Requires: punch machine S002, 10 minutes for setup, can produce 60 per hour.

press (1.1.4) Requires: press machine S003, 2 minutes for setup, and 1 minute per piece.

cut (1.1.2) - 350-ID Plate Requires: plasma cutter S001, 4 minutes for setup, load time per sheet is 1 minute, 1 sheet gives 50 parts, 20 seconds per part.

punch (1.1.3) - 350-ID Plate Requires: punch machine S002, 10 minutes for setup, can produce 50 per hour.
Temporal constraint: 1.1.4 can start when 50% of the parts are punched.

cut (1.1.5) Requires: plasma cutter S001, 20 minutes for setup, one sheet of metal yields 50 bodies, 1/2 minute per piece.

press (1.1.6) Requires: press machine S003, 1/2 minute per piece.

press (1.1.7) Requires: press machine S003, 15 minutes for setup, and 20 seconds per piece.

The object state transitions for the production of 350-License, x50-Body, 350-ID Plate and the unpainted 350-Frame are shown in figure 7². These diagrams show the flow of the “work in progress” items. In all of these cases, the initial material begins with a supply of sheet metal. For the 350-License, the sheet metal is pressed into the final item. The x50-Body is first transformed into a cut metal part before being pressed into the x50-Body shape. Finally, both the 350-ID Plate and the (unpainted) 350-Frame are cut, punched, and pressed at the sheet metal department.

²Note that while the IDEF3 referents (e.g. cut, press, etc.) in this figure are attached to the state nodes, next to their associated transition arc, they are semantically the same as the referents attached directly to the arc in other figures.

5.4 Machine Shop

The machine shop provides tooling for a two GT-350 parts using a supply of purchased stock and a store of items produced at the foundry. The parts manufactured include: 350-Block and an unpainted 350-Stand.

There are 5 FMS (flexible manufacturing system) machines in the machine shop (M001–M005). These machines can be classed by the type of tooling they can perform. Centres M001–M002 can perform any FMS function on any part (i.e. A or B class tooling). Centres M003–M004 can be used for B class tools whereas M005 can only be used for A class tools. The alternate sequences of production steps are shown in figure 8. These sequences represent unique, high-level activity paths enacted within the shop. The particular sequence performed depends on the part which is being produced. The object state transition diagram for the machine shop in figure 9 ties an activity flow to the particular manufactured part.

The process steps require the following materials and resources:

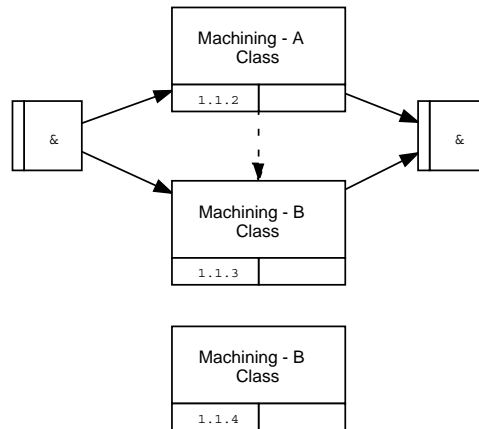

Figure 8: Production Steps in the machine shop department

machining - A class (1.1.2) Requires: a FMS (M001, M002, or M005), a 350 fixture, an A1, A2, A3 class tool, a pallet, 1 minute for setup, takes 2 minutes. Note: The relational link between these two IDEF activities indicates a specialised relationship. In this case, the relationship expresses the fact that either can be performed before the other, but they cannot be performed in parallel.

machining - B class (1.1.3) Requires: a FMS (M001, M002, M003, or M004), a 350 fixture, a B1 tool, a pallet, 1 minute for setup, takes 5 minutes.

machining - B class (1.1.4) Requires: a FMS (M001, M002, M003, or M004), a 350 fixture, a B1 and B2 tool, a pallet, 1 minute for setup, takes 12 minutes.

In scheduling, the following facts must also be accounted for:

- varying capabilities. M001–M002 can perform any FMS function on any part (i.e. A or B class tooling) whereas M003–M004 can perform work up to and including 1/4" tooling (B class tools). Centre M005 handles any tooling greater than 1/4" tooling (A class tools).

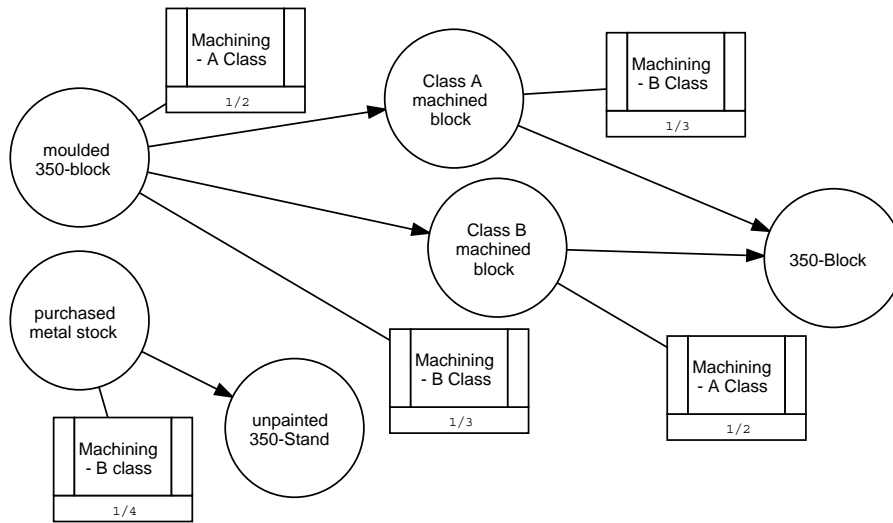

Figure 9: Object state transitions in the machine shop department

- scheduler needs to know that the machine shop is constrained to 5000 parts from which suitable parts are selected to ensure FMS utilisation.
- different setup times between resources, i.e. M002 can setup the job in 1/3 the time of M001. M002 can perform any task in 1/2 the time, whenever possible M001 is preferred over m002.
- a minimum 250 parts can be processes at a time.
- it takes 30 seconds to load each part during the setup phase and 45 seconds to unload each part when unloading.

The object state transitions for the production of the 350-Block and the unpainted 350-Stand are shown in figure 9. These diagrams show the flow of the “work in progress” items. The input material for the completed 350-block is a moulded block produced in the foundry. Since the A class machining or B class machining can be done in either order there are two possible transitions paths for the 350-Block. The 350-stand is made by B class machining a specialised purchased metal stock item.

5.5 Wire and Cable

The Wire and Cable department produces the 350-harness and 350-wire-set. The 350-wire-set is composed of 12 lengths of 350-wire. The cable used in the harness and wire set is made from rods of metal which are extruded into thinner lengths of wire. These are twisted, and then covered with a coloured jacket.

There are five machine resources in the Wire and Cable department: extruder W001, twisters W002-3, and jacket lines W004-5.

Use of the resources is restricted as follows: The cable produced by twister W002 must be input to jacket line W004, and similarly for W003 and W005. There is no storage between extruder and twisters. There are no constraints on storage between twisters and jacket lines. The two jacket lines cannot operate on the same colour of cable at the same time.

Two processes are enacted in the rubber works: *make 350-harness* and *make 350-wire-set*. Figure 10 shows the processes of *make 350-harness*. These process steps require the following materials and resources:

make harness:

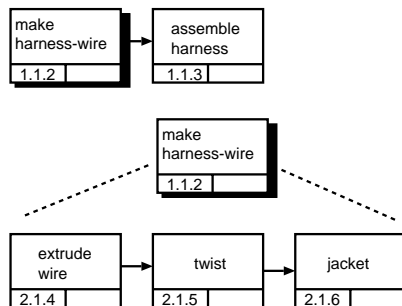

Figure 10: Production steps in the wire and cable department

extrude wire Requires: extruder W001, 20 feet of rod is required to produce 500 yards of wire, the lengths of rod must be multiples of 40 feet. The extruder has a setup time of 20 minutes. 20 feet of output is produced per minute, and 15% of the output is scrap.

twist Requires: twister W002, 1500 yards of wire is required to produce 500 yards of cable. 10 feet of output is produced per minute, and 5% of the output is scrap.

jacket Requires: jacket line W004. The colour of the jacket can be changed while the the machine is in operation. The jacket line has setup time of 2 minutes per 50 feet to jacket. The processing rate is 7 feet per minute, and each cable is 12 inches long.

assemble harness Requires: 10 minutes is required per set.

Figure 11 shows the processes of *make 350-wire-set*. These process steps require the following materials and resources:

make wire set:

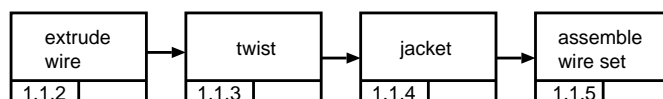

Figure 11: Production steps in the wire and cable department

extrude wire Requires: extruder W001, 20 feet of rod is required to produce 500 yards of wire, the lengths of rod must be multiples of 40 feet. The extruder has a setup time of 20 minutes. 30 feet of output is produced per minute, and 7% of the output is scrap.

twist Requires: twister W002 or W003, 1500 yards of wire is required to produce 500 yards of cable. An extra 15% is always extruded and twisted to account for wastage. 10 feet of output is produced per minute, and 5% of the output is scrap.

jacket Requires: jacket line W004 or W005, depending on the choice of twister The colour of the jacket can be changed while the the machine is in operation. The jacket line has setup time of 2 minutes per 50 feet to jacket. The processing rate is 7 feet per minute, and each cable is 6 inches long and is blue.

assemble wire set Requires: 5 minutes is required per set.

The object state transition diagrams for the 350-harness and 350-wire-set are very similar, as illustrated in Figure 12. The input material is metal rods, which are extruded into wire. This is then twisted into cable, which is covered. Two different assembly processes produce the final items. That the colour of the cable can be changed during jacketing is indicated by the two states *covered cable - colour #1*, and *covered cable - colour #2*. It has been assumed that the cable is being produced primarily for the harness/wire-set, and that any overrun (of a possibly different colour) will be stored.

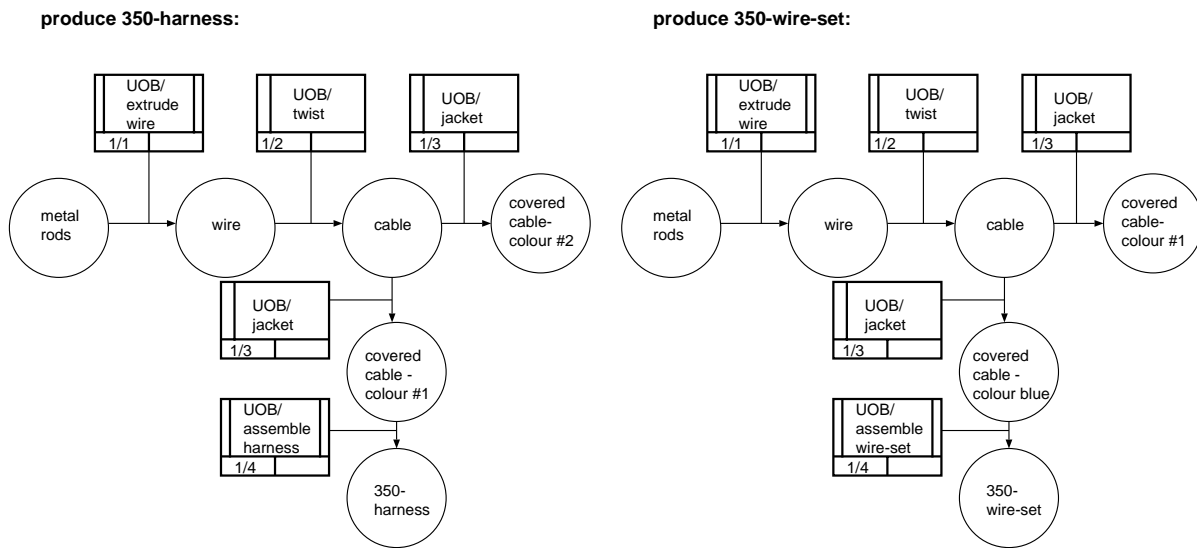

Figure 12: Object state transitions in the wire department

5.6 Electronics

The Electronics department produces the 350-PCB, an electronic unit which controls the functions of the 350 model. A unit for another model is also produced. The components to be mounted on the 350-PCB are first assembled, and the board is screened. A number of components are inserted automatically, others are then inserted by hand. The boards are soldered and stress tested. A functional test is applied to a proportion of each batch. Depending on the results of this test, the batch may be passed, failed, or reworked. Boards are not reworked more than once.

There are eleven machine and work area resources in the Electronics department: prep E001, screen E002, auto-insert E003-4, manual (insert) E005-7, solder E008, stress E009, test E010, and rework E011.

Use of the resources is restricted: Screening should not take place more than 1.5 hours before E003 or E004 is expected to be ready. If the delay between screening and auto-insertion is more than two hours, then the boards must be washed and dried - this takes two hours. Each of E003 and E004 has a post-process queue, and there are no pre-process queues at the manual stations E005-7. E003 processes two boards in parallel. E004 processes one board at a time, but loading can take place during processing. The solder machine uses a conveyor belt - maximum capacity 24 boards. The stress test machine E009 has five chambers. If chamber one is used then chamber two must also be used. Batches cannot be mixed in a chamber, and a chamber must be full to operate. Work coming out of E009 remains in the output queue until all of the batch has been completed.

The production process is illustrated in Figure 13. These process steps require the following materials and resources:

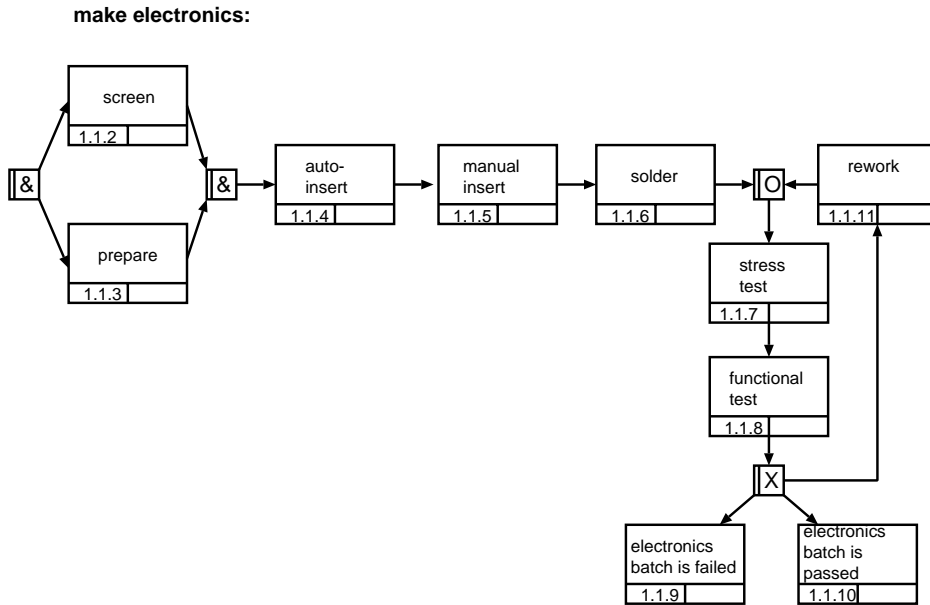

Figure 13: Production steps in the Electronics department

prepare Requires: prep E001, takes 2 hours.

screen Requires: screen E002, setup time 15 minutes, each board takes 15 minutes to process. After screening, each batch must sit for 5 minutes before further work.

auto insert Requires: auto-insert E003, each board takes 5 minutes to process.

manual insert Requires: manual insert E005 or E007, each board takes 2 minutes to process.

solder Requires: solder E008. If a part of the same type has been processed within the past 2 hours no setup is required, if the time elapsed is greater than 2 hours the setup time is 1.5. If a part of a different type was the last to be processed, then setup time is 3.5 hours. The conveyor runs at 2 feet per minute. Each board occupies 1 foot. 350-PCB can be loaded side-by-side, doubling the capacity of E008.

stress test Requires: stress E009. 10 350-PCBs fit in a chamber. A stress test lasts 24 hours. Once started, a test cannot be interrupted.

functional test Requires: test E010. Testing takes 10 minutes per board. 100% of 350-PCBs are tested. Boards which fail are removed from the batch and may be reworked.

electronics batch is passed The batch passes if the sample tested passes.

electronics batch is failed The batch fails if the sample tested fails, and the batch has already been reworked.

rework Requires: rework E011, takes 20 minutes per piece. Pieces which fail the functional test, and have not already been repaired are reworked. Reworked boards go back through the stress test and functional test.

The following statistics are typical of these processes: 15% of the output of the stress test is scrapped, 15% is reworked, and 70% goes to the functional test. In the functional test: 80% of second pass parts are scrapped, 20% of second pass parts continue to stores, while 90% of first pass parts continue to stores and 10% are reworked. 5% of all parts entering rework are scrapped afterwards.

In scheduling, the following facts must also be accounted for:

- the shift profile is 8.00am-4.00pm and 3.00pm-11.00pm, i.e. shifts overlap.
- the screen E002 requires 4 hours of preventative maintenance every 10 elapsed days (including weekends), the closest working shift performs the cleaning.
- operator efficiency at the manual stations E005-E007 varies: a new operator will work at 50% of the standard rate for the first 2 weeks, 75% for the next week, 85% for the next week, and at 100% of the standard rate thereafter.
- the mean time between failure of the solder machine E008 is 500 hours, mean time to repair is 2 hours.
- the stress test E009 works 24 hours a day, 7 days a week. Shift and holiday premiums are paid to the operators.

The object state transition diagram for the 350-PCB is illustrated in Figure 14. Component kits and screened boards are created from stock components. An assembled PCB is constructed from these. Testing changes the status of these boards from assembled, to stressed, then to operational. The functional test may return a board to the assembled status, or may change the status to scrap.

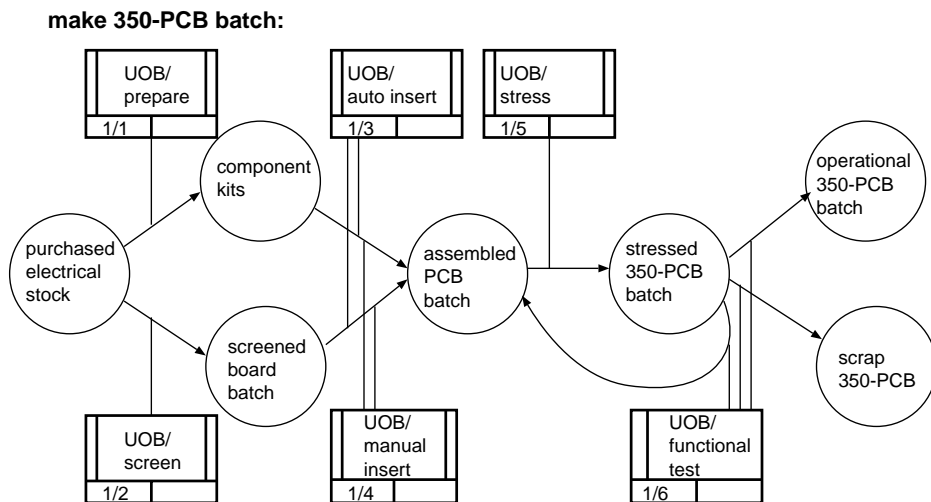

Figure 14: Object state transitions in the Electronics department

5.7 Paint

The paint department provides the desired colour for two of the GT-350 parts using a store of items produced by the machine shop and sheet metal departments. The painted parts include: 350-Frame and the 350-Stand.

There is one main paint conveyor line (P001) in the paint department along with 3 paint booths (P002–P004). One of the main considerations for these resources is the current colour which exists in the paint line. A changeover from one colour to the next may be required and the time it takes to perform this activity depends on the existing and desired colours.

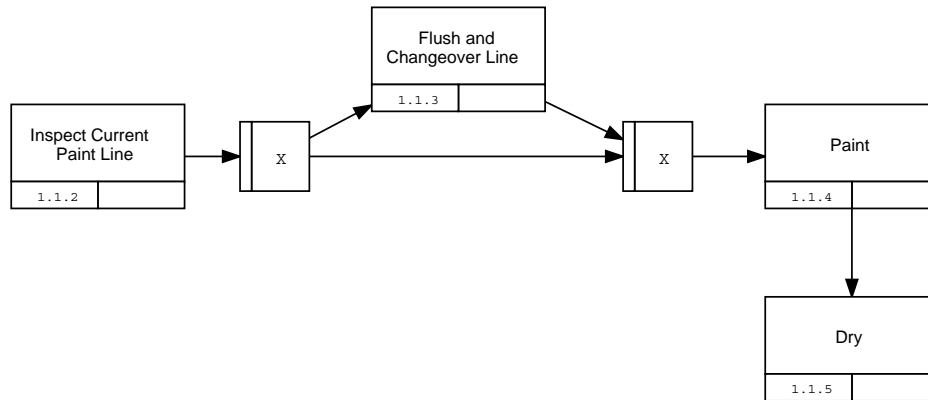

Figure 15: Production steps in the paint department

The production steps are shown in figure 15. These sequences represent a repeatable process path enacted within the paint department. The high-level activities include inspecting the line status and optionally performing a changeover. Once items are painted, they must be allowed to dry. The object state transition diagram in figure 16 provides more information about the various states the products go through while in the paint department.

The process steps require the following materials and resources:

inspect current paint line Requires: primary paint resource (P001–P004), takes less than 1 minute.

flush and changeover line Requires: primary paint resource (P001–P004), can take the following amount of time:

- changeover time paint from white to red 2 minutes
- changeover time paint from red to white 10 minutes
- changeover time from metal to any other colour is 3 minutes
- changeover time to metal from any other colour is 5 minutes

paint Requires: primary paint resource (P002–P004), travel time through the booth is 20 minutes for each part

dry Requires: paint conveyor (P001), drying time for red and metal is 4 hours, white is 6 hours.

In scheduling, the following facts must also be accounted for:

- the line must be flushed during the last hour of each shift

- up to 100 parts can be in the line at the same time
- for P002–P004, cleaning of equipment must be performed after every 5000

The object state transition diagram in figure 16 illustrates the state of products in the paint department. This simply points out the transition from unpainted, to an intermediate, wet paint stage, before reaching the final dry, finished product.

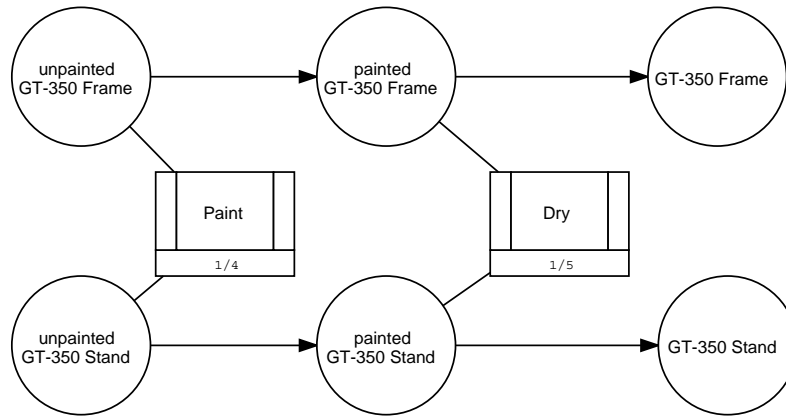

Figure 16: Object state transitions in the paint department

5.8 Final Assembly

The final assembly area is responsible for completing the integration of the product subcomponents. This also includes performing some of the final product modifications (e.g. engraving). This department produces the completed GT-350 product.

There are 5 bench assembly areas (A001–A005). Any bench can service or work on the GT-350. The GT-350 assembly uses an expensive adhesive which once opened is only good for two days and contains enough adhesive for twenty models.

The production steps are shown in figure 17. These sequences represent a repeatable process path enacted within the assembly department. The high-level activities include splitting the subcomponent batches into kits (1 per model). A kit is first partially assembled in assemble-1. The dashed relation link between this activity and the engraving-1 activity is used to indicate a special temporal link. In this case the interrelationship is that engraving-1 can overlap the last 5 minutes of the assemble-1 step. Once the engraving-1 and assemble-1 steps have been completed, the product undergoes a final assembly and engraving step.

The process steps require the following materials and resources:

split into kits Requires: worker, subcomponent batches.

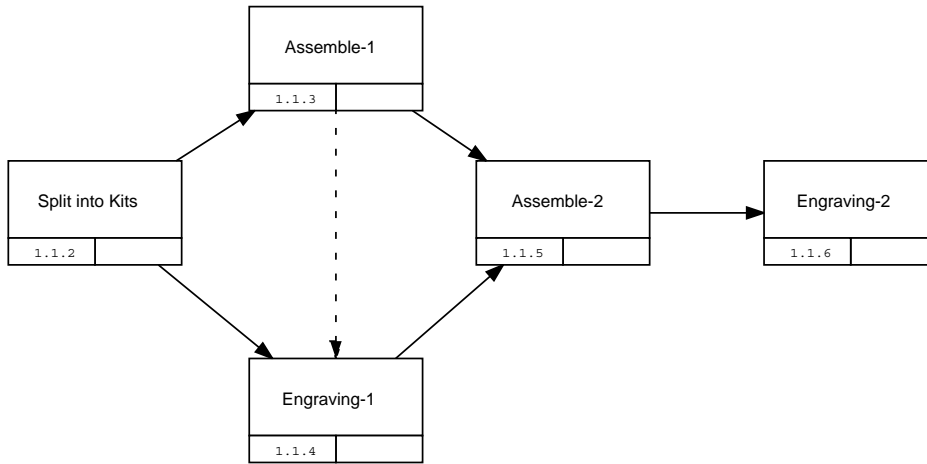

Figure 17: Production steps in the assembly department

assemble-1 Requires: a bench worker, an assembly bench (A001–A005), takes 35 minutes per piece.

engraving-1 Requires: an engraver, same bench as assemble-1, takes 10 minutes.

assemble-2 Requires: same worker who performed assemble-1, an assembly bench (A001–A005), takes 30 minutes.

engraving-2 Requires: an Engraver, an assembly bench (A001–A005), takes 5 minutes.

The object state transition diagram in figure 18 illustrates the state of a GT-350 product in the final assembly department. These states go through partially assembled and completely assembled before the final engraving is made to complete the process.

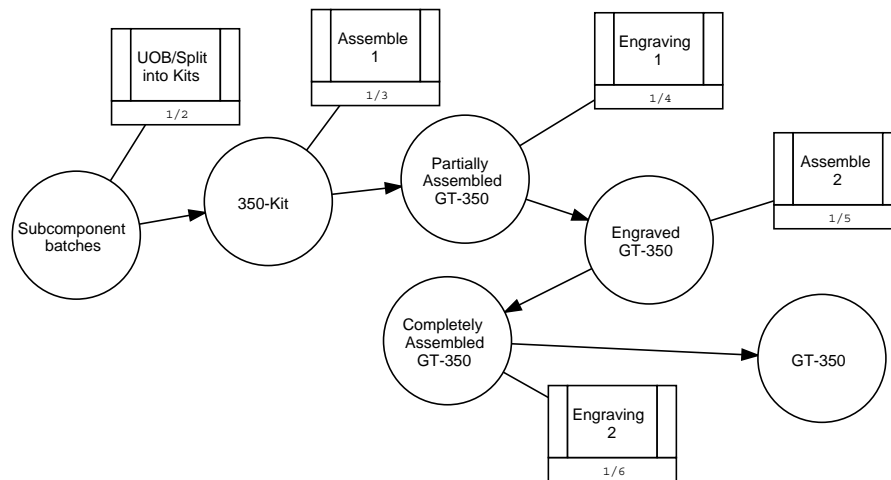

Figure 18: Object state transitions in the assembly department

6 GT-350 Manufacturing Processes

This section unites the various departmental processes into a high-level collection of activities which are enacted to create a GT-350 product. As described in the GT-350 product structure (table 1), subcomponents of this product are either purchased, sub-contracted, or made internally. These process descriptions address the activities performed to manufacture the internal subcomponents. This top-down view of the manufacturing process provides an overall picture from an abstract, “make GT350” activity which is expanded down to the detailed departmental levels.

As figure 19 shows, the GT-350 manufacturing process is divided into 6 main areas of work. The first five: make interior, make drive, make trim, make engine and make chassis are all unordered with respect to each other but they must all be completed before final assembly takes place.

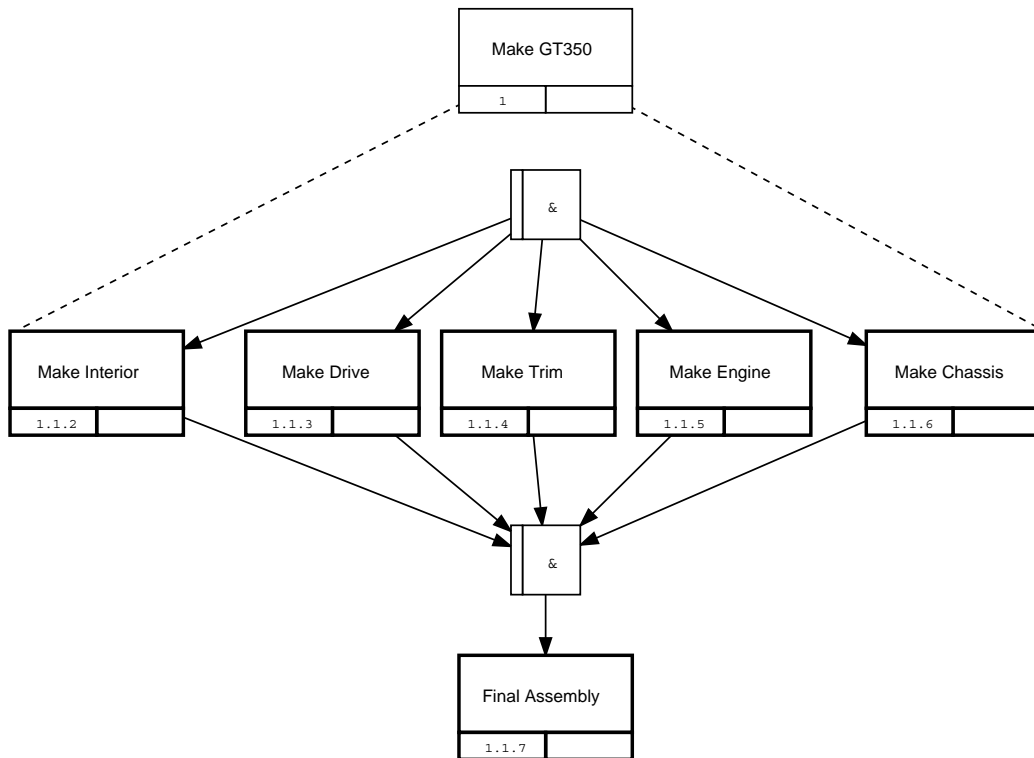

Figure 19: Top level process for manufacturing a GT-350

Each of these abstract activities are further detailed below. This includes references back to the departments which are responsible for the completion of the high level steps. Many of these steps involve work from more than one department.

6.1 Make Interior

The interior of the GT-350 is composed of a cockpit, seats, and a gear shift. The first two items are purchased and used in the assembly of the interior. The only internally manufactured part is the gear shift. The process for producing the gear shift is detailed in the rubber works (section 5.2). The assembly of the interior requires the A002 assembly bench and takes 3 minutes per kit.

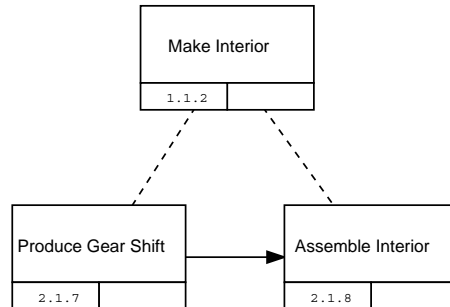

Figure 20: Process for manufacturing the 350-Interior

6.2 Make Drive

The drive for the GT-350 is made up of two parts: the motor and the electronics. The motor comes from a purchased stock and is used in the assembly of the 350-Drive. The bulk of work for this process lies in the production of the electronics which interface with the motor. This is manufactured as part 350-PCB in the electronics department. The “make electronics” process is detailed in section 5.6. The assembly of the drive requires the A002 or A003 assembly bench and takes 12 minutes per piece.

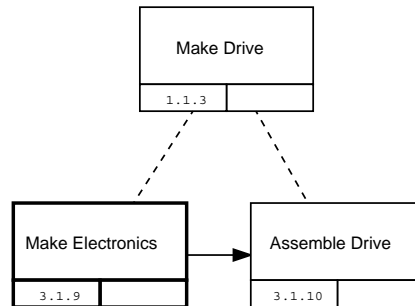

Figure 21: Process for manufacturing the 350-Drive

6.3 Make Trim

The 350-Trim is assembled from work performed in several CMW departments. The manufacturing process is shown in figure 22. This includes the production of the following components: 350-Options, 350-Wheels, 350-Decals, 350-ID Plate, and the 350-Stand. The only addition to this are the 350-Decals which are purchased. The following parts

are further defined below: 350-Options in figure 23; 350-Wheels in figure 24; and 350-ID Plate in figure 25. The 350-stand is manufactured via consecutive operations in the machine shop and paint department (see sections 5.4 and 5.7 respectively). The assembly of the trim requires the A002 or A005 assembly bench and takes 20 minutes per piece.

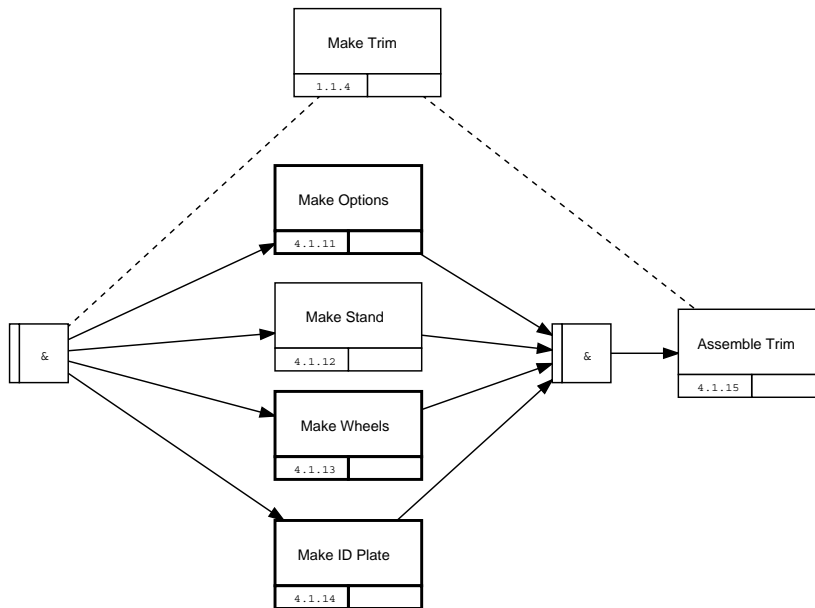

Figure 22: Process for manufacturing the 350-Trim

6.3.1 Make Options

The 350-Options are manufactured as part of the 350-Trim sub-assembly. For the GT-350, this indicates the production of the “optional” license plates. Note that this routing is attached to a work order that is automatically activated if the license plate option is selected at time of order acceptance (the license plate from the state/province/or country is attached). The “press” step is further detailed in the sheet metal department (section 5.3). The stamping step requires a bench worker, the sheet metal bench and takes 5 minutes for setup as well as 2 minutes to complete. There is an exception to this execution time though if a “personal message” option is taken and then the time takes 1 minute per special character on the plate.

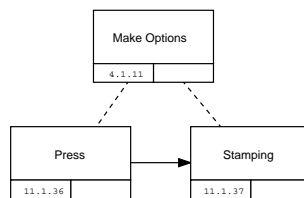

Figure 23: Process for manufacturing the 350-Options

6.3.2 Make Wheels

The 350-Wheels are manufactured as part of the 350-Trim sub-assembly. This involves an integration of work from the foundry and rubber works. See section 5.1 for details on the production of the x50-Rims. See section 5.2 for details on the production of the 350-Tires. The 350-Wheels are assembled at the foundry bench by a foundry operator. This takes 1/4 minute per wheel.

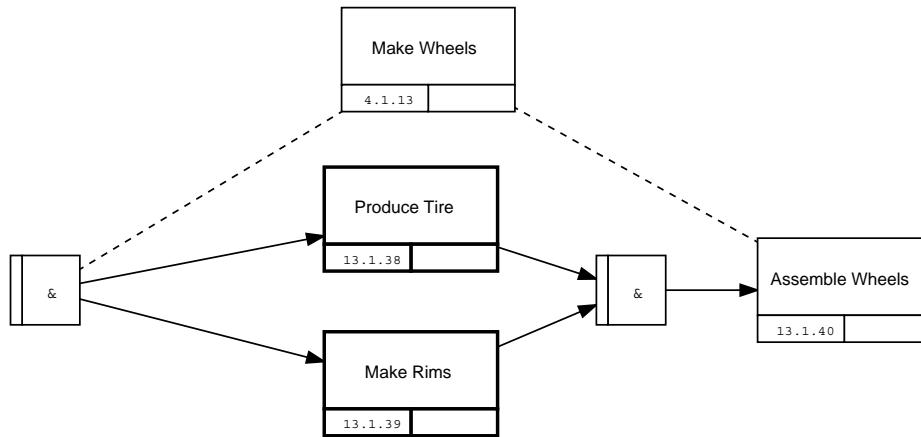

Figure 24: Process for manufacturing the 350-Wheels

6.3.3 Make ID Plate

The 350-ID Plate is manufactured as part of the 350-Trim sub-assembly. The expansion is shown below in figure 25. This expansion mirrors the three steps performed in the sheet metal department: cut, punch, press. See section 5.3 for the details on these activities.

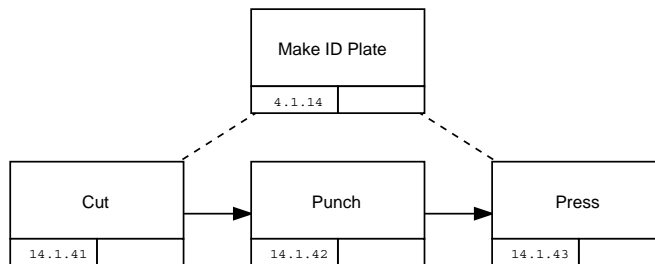

Figure 25: Process for manufacturing the 350-ID Plate

6.4 Make Engine

The 350-Engine is assembled from work performed in several CMW departments. The manufacturing process is shown in figure 26. The part is made up of an engine block, a harness, and wiring. The sub-processes are detailed in sections: 27, 28 and 30. The 350-Engine is assembled at the A004 assembly bench and takes 5 minutes per piece.

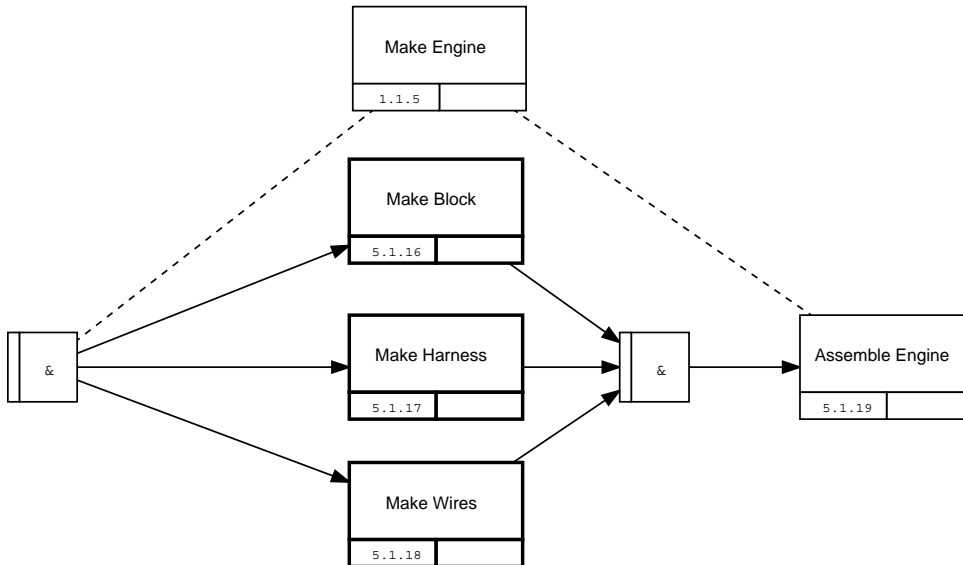

Figure 26: Process for manufacturing the 350-Engine

6.4.1 Make Block

The 350-Block is manufactured as part of the 350-Engine sub-assembly. This involves an integration of work from the foundry and machine shop. See section 5.1 for details on the production of the moulded 350-Block. See section 5.4 for details on the final tooling operations.

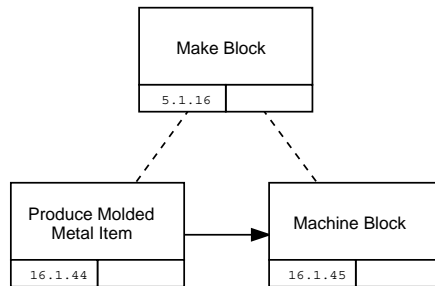

Figure 27: Process for manufacturing the 350-Block

6.4.2 Make Harness

The 350-Harness is manufactured as part of the 350-Engine sub-assembly. This involves work performed at the wire and cable department. See section 5.5 for details on the production of the harness. Figure 29 expands the harness wire production process. The 350-Harness is assembled by a bench worker at a wire and cable bench. It takes 10 minutes per set.

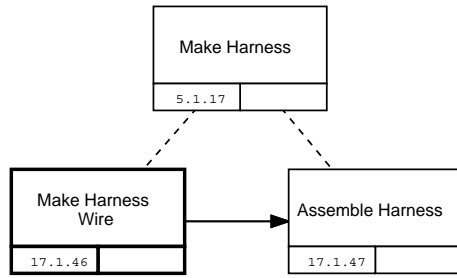

Figure 28: Process for manufacturing the 350-Harness

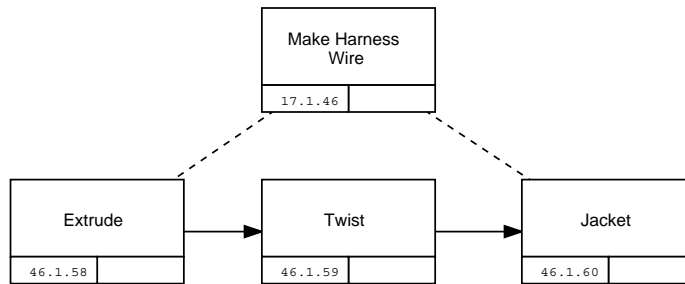

Figure 29: Process for manufacturing the 350-Wire

6.4.3 Make Wires

The 350-Wire-Set is manufactured as part of the 350-Engine sub-assembly. This involves work performed at the wire and cable department. See section 5.5 for details on the production of the wire set. Figure 30 expands the wire set production process. The 350-Wire-Set is assembled by a bench worker at a wire and cable bench. It takes 5 minutes per set.

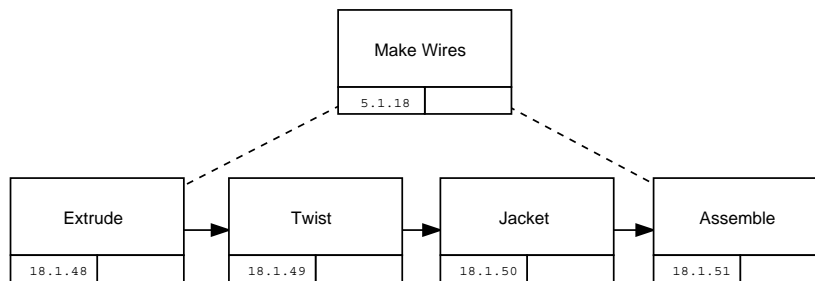

Figure 30: Process for manufacturing the x50-Wire

6.5 Make Chassis

The 350-Chassis is assembled from work performed in several CMW departments. The manufacturing processes are shown in figure 31. The part is made up of a frame and a body. The sub-processes are detailed in sections: 32 and 33.

The 350-Engine is assembled at the A002 assembly bench and takes 50 minutes per piece.

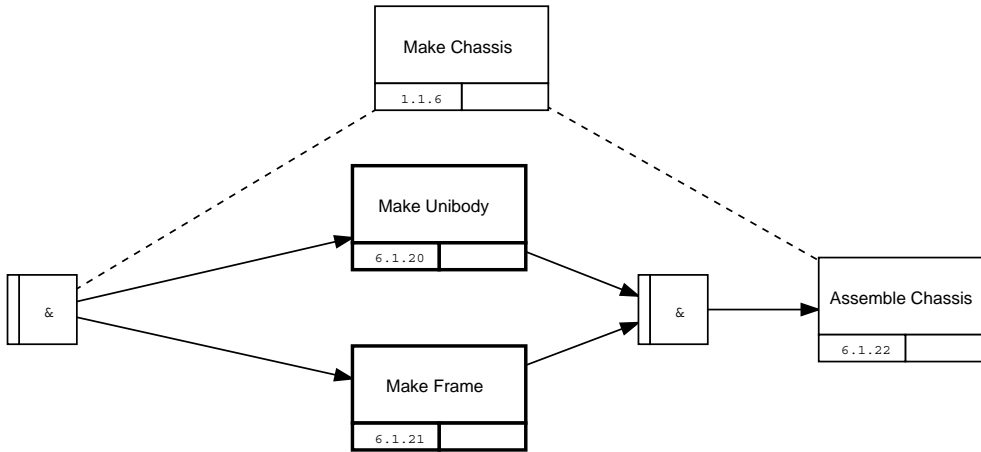

Figure 31: Process for manufacturing the 350-Chassis

6.5.1 Make Unibody

The x50-Body is manufactured as part of the 350-Chassis sub-assembly. This involves work performed at the sheet metal department. See section 5.3 for details on the cut and press steps involved in the production of the body.

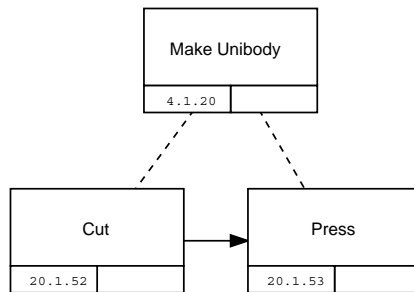

Figure 32: Process for manufacturing the 350-Body

6.5.2 Make Frame

The 350-Frame is manufactured as part of the 350-Chassis sub-assembly. This involves work performed at the sheet metal and paint departments. See section 5.3 for details on the cut, punch and press steps and section 5.7 for the paint step involved in the production of the frame.

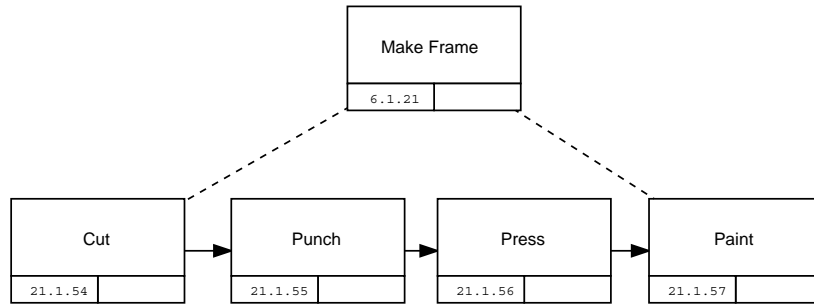

Figure 33: Process for manufacturing the 350-Frame

6.6 Final Assembly

The various sub-components for the GT-350 product are brought together for the final assembly process. This process is outlined in figure 34. See section 5.8 for details on the assembly and engraving steps.

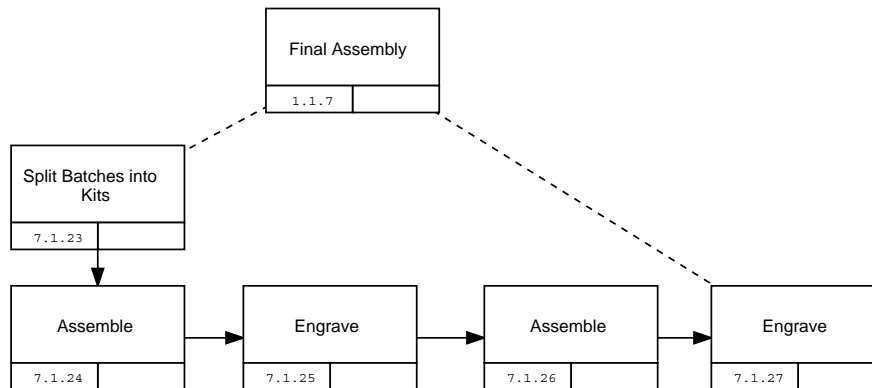

Figure 34: Process for final GT-350 assembly

7 GT-350 Manufacturing Material Flow

The manufacturing processes enacted within the CMW factory can be viewed from a material flow perspective alongside the top-down activity-centred presentation. In this way, the factory steps can be examined as a set of state transitions from raw or purchased materials through intermediate part states to a final, finished GT-350 product state. Figure 35 presents a simplified view of the aggregate material flow diagrams (IDEF3 object state transition networks) that were presented in each of the departmental descriptions. The source materials include: solid metal compound, solid rubber compound, metal rods, sheet metal, purchased metal base, and purchased electrical stock. These materials are transformed into a set of sub-component batches which are split into a kit before finally becoming the GT-350.



Figure 35: Flow of materials for production of the GT-350

8 Source and Target Languages

This section presents an example of an interoperability implementation which has been sketched out to show what needs to be done when two existing representations are chosen. A possible source (IDEF3) and target (ILOG Scheduler) language for this manufacturing process interoperability scenario were introduced in section 2.1. Development of translators to and from these languages depends on the ability to express these representations in a machine readable format. This section provides a simple example of a textual input/output format for both the source and target languages using a few GT-350 manufacturing steps which were described above.

8.1 IDEF3: Process Representation

IDEF3 [Mayer *et al.* 92] facilitates the capture of the description of what a system (or factory) actually does. Thus, knowledge acquisition is enabled by providing a mechanism whereby the assertions about the CMW manufacturing steps can be expressed. The scenario description provided above has been presented using the IDEF3 process and object centred graphical notation. What is required for automatic or semi-automatic translation though is a machine readable format. Unfortunately, a standard for this representation has not been established as yet. A preliminary frame representation for IDEF3³ is used below to illustrate this possible format.

```
;;;;;;;;;;;;;;  
;;; IDEF3 representation  
  
;;; process  
  
(define-process Make-350-Frame  
  :components Cut-1 Punch-1 Press-1  
  :constraints nil)  
  
;;; classes of "unit of behavior"  
(define-UOB Cut  
  :object s001-plasma-cutter  
  :facts  
  :constraints)  
  
(define-UOB Punch  
  :object s002-punch-mach  
  :facts  
  :constraints)  
  
(define-UOB Press  
  :object s003-press-mach  
  :facts  
  :constraints)  
  
;;; Objects
```

³This IDEF3 textual format is based on an initial specification by Chris Menzel at Knowledge Based Systems, Inc. (KBSI)

```

(define-object s001-plasma-cutter
  :constraints)

(define-object s002-punch-mach
  :constraints)

(define-object s003-press-mach
  :constraints)

;;; UOB instance
(define-UOB-use Cut-1
  :use-of Cut
  :successors Punch-1
  :decomp nil)

(define-UOB-use Punch-1
  :use-of Punch
  :successors Press-1
  :decomp nil)

(define-UOB-use Press-1
  :use-of Press
  :successors nil
  :decomp nil)

```

8.2 ILOG Schedule: Scheduling

Currently, the industrial development of flexible constraint-based scheduling systems is facilitated by the emergence of object-oriented constraint programming tools. An excellent example of this type of approach is ILOG Scheduler [Pape 94]. ILOG Scheduler is a library which enables the representation of a wide collection of scheduling constraints. The model consists of a set of C++ classes, methods, and functions that implement the concepts of **resource** and **activity** in terms of ILOG Solver variables and constraints. ILOG Scheduler is based on ILOG Solver, the generic software tool for object-oriented constraint programming developed and marketed by ILOG. The following file example illustrates one way that part of the scheduling of the CMW may be represented in ILOG Scheduler.

```

/* ILOG Schedule representation */

void DefineProblem(IlcSchedule schedule) {

  /* create the activities */

  IlcIntervalActivity cut-1(schedule, 4);
  IlcIntervalActivity punch-1(schedule, 1);
  IlcIntervalActivity press-1(schedule, 3);

  /* post the temporal constraints */

```



```

IlcPost (punch-1.startsAfterEnd (cut-1));
IlcPost (press-1.startsAfterEnd (punch-1));

/* create the resources */

IlUnaryResource s001-plasma-cutter(schedule);
IlUnaryResource s002-punch-mach(schedule);
IlUnaryResource s003-press-mach(schedule);

/* post the resource constraints */

IlcPost (cut-1.requires (s001-plasma-cutter, 1));
IlcPost (punch-1.requires (s002-punch-mach, 1));
IlcPost (press-1.requires (s003-press-mach, 1));
}

```

9 Summary

This document has presented a manufacturing scenario description in which the Process Specification Language (PSL) could be used to facilitate the interoperability of manufacturing tool knowledge. A sketch of an implementation of this interoperability was provided in section 8. The next step is to implement the full description in the source language based on the detail of Sections 5-7 which would be encoded as in section 8. Translators are required to map these concepts onto the PSL constructs and from PSL to the scheduling representation as suggested in section 8. This will involve the identification and grouping of the underlying PSL concepts which will require collaboration between all of the PSL team efforts.

Acknowledgements

This work has been sponsored by the National Institute of Standards and Technology (NIST) Grants Office, Gaithersburg, Maryland 20899-0001 USA which is an operating unit of the U.S. Department of Commerce under award number 70NANB8H0009. The performing organisation for this work includes members of the Artificial Intelligence Applications Institute, University of Edinburgh, Edinburgh EH1 1HN, UK.

References

- [Gruninger *et al.* 97] M. Gruninger, C. Schlenoff, A. Knutilla, and S. Ray. Using process requirements as the basis for the creation and evaluation of process ontologies for enterprise modeling. *ACM SIGGROUP Bulletin Special Issue on Enterprise Modelling*, 18(3), 1997.
- [Knutilla *et al.* 97] A. Knutilla, C. Schlenoff, S. Ray, S. Polyak, A. Tate, S. Cheah, and R.C. Anderson. Process specification language: An analysis of existing representations. Technical Report NISTIR, National Institute of Standards and Technology, Gaithersburg, MD, 1997.
- [Mayer *et al.* 92] R.J. Mayer, T.P. Cullinane, P.S. deWitte, W.B. Knappenberger, B. Perakath, and M.S. Wells. Information integration for concurrent engineering (IICE) IDEF3 process description capture method report. Technical Report AL-TR-1992-0057, Armstrong Laboratory, Logistics Research Division, Wright-Patterson AFB, OH 45433 USA, 1992.
- [McKay & Moore 91] K.N. McKay and J.B. Moore. Intelligent manufacturing management program: State of the art scheduling survey. Technical Report R-91-IMM-01, CAM-I, 1250 E. Copeland Road, Suite 500, Arlington, TX 76011 USA, 1991.
- [Pape 94] C. Le Pape. Implementation of resource constraints in ilog schedule: A library for the development of constraint-based scheduling systems. *Intelligent Systems Engineering*, 3(2):55-66, 1994.
- [Polyak & Tate 97] S.T. Polyak and A. Tate. Analysis of candidate PSL process/plan representations. Technical Report AIAI-PR-66, Artificial Intelligence Applications Institute, Edinburgh, UK, 1997.
- [Schlenoff *et al.* 96] C. Schlenoff, A. Knutilla, and S. Ray. Unified process specification language: Requirements for modeling process. Technical Report NISTIR 5910, National Institute of Standards and Technology, Gaithersburg, MD, 1996.
- [Schlenoff *et al.* 97] C. Schlenoff, A. Knutilla, and S. Ray. Proceedings of the process specification language (PSL) roundtable. Technical Report NISTIR 6081, National Institute of Standards and Technology, Gaithersburg, MD, 1997.